

HYDRAULIC DIRECTIONAL CONTROL VALVES РАСПРЕДЕЛИТЕЛИ ГИДРАВЛИЧЕСКИЕ

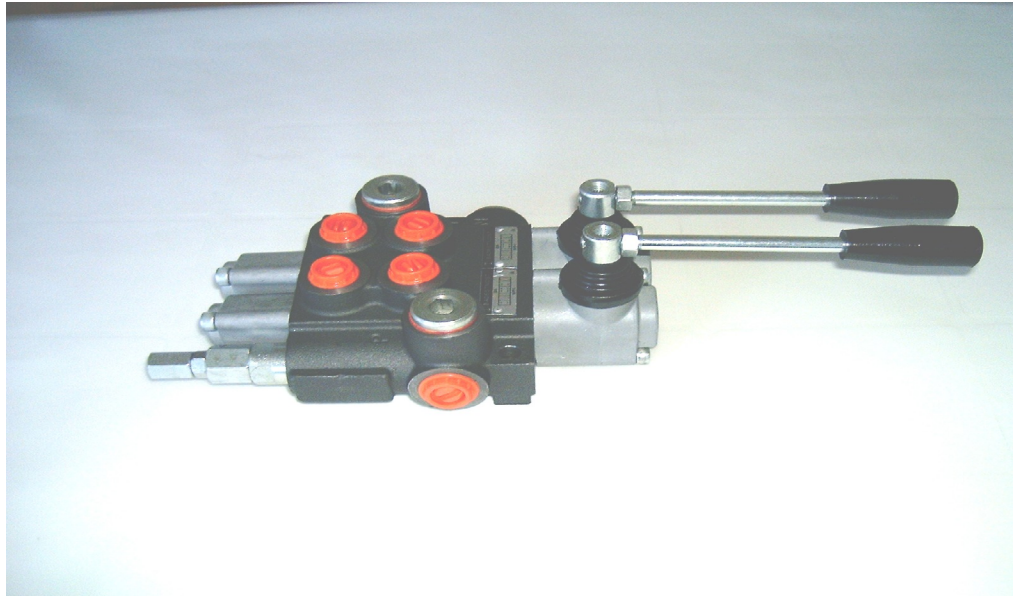

Description

Назначение и область применения:

For starting, controlling and stopping the working fluid between the generator of pressured flow, the consumers and the Tank. Предназначен для изменения направления потока, ограничения давления рабочей жидкости в гидролиниях, разгрузки насоса в нейтральной позиции золотников.

Specifications

Основные показатели:

1. Valve monoblock	моноблок
Конструктивное исполнение	2 bolts M8
2. Mounting	
Крепление	
3. Pressure connections	internal thread
Присоединительные отверстия	внутренние резьбы
4. Ambient temperature	-40C...+60C
Температура воздуха	
5. Pressure medium	mineral oil based hydraulic oil
Рабочая жидкость	
6. Viskosity	12...800 mm ² /s permissible range
Кинематическая вязкость	20...100 mm ² /s recommended range
7. Fluid temperature	-15C...+80C
8. Filtration	Oil contamination 10 to NAS1638
9. Max. operating pressure	P = 250 bar
Давление max. bar	T = 50 bar
	A, B = 300 bar
	7 cm ³ /min at 100 bar
10. Internal (46 mm ² /s) Leakage	
Внутренние потери (A, B – T)	
11. Nominal flow	40 l/min (see “operating” diagram)
Разход рабочей жидкости	
12. Spool stroke	±6 mm
Ход золотника	
13. Actuating force	< 200 N in spool axis direction
Усилие на движения золотника	

Left hand configuration - standart

Right hand configuration

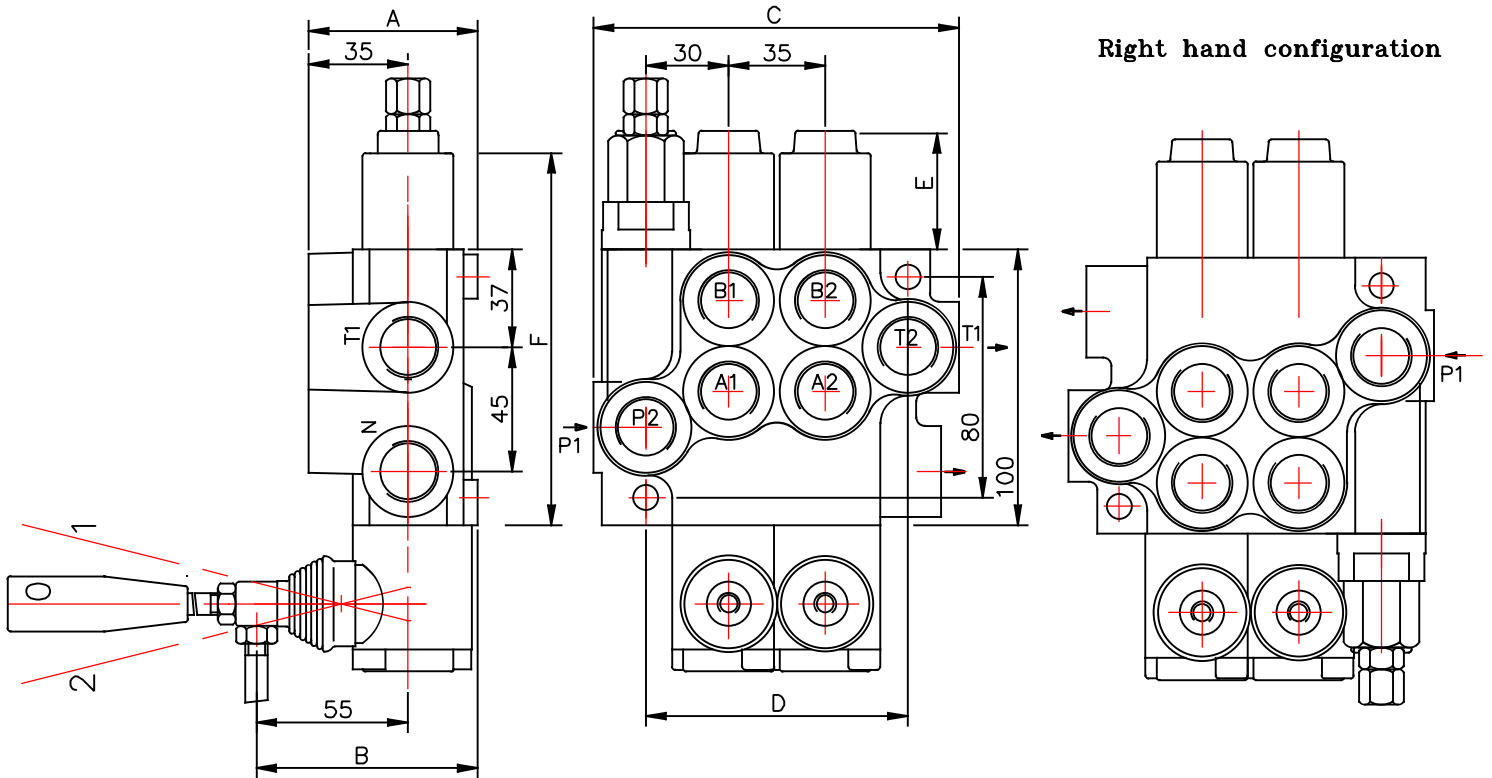

Table 1

	A	B	C	D	P1	P2	T1	T2
P40	60	80	85	60	+	-	+	-
02P40	60	80	129	97	+	+	+	+
03P40	60	80	164	132	+	+	+	+
04P40	60	80	199	167	+	+	+	+
05P40	60	80	234	202	+	+	+	+
06P40	60	80	269	237	+	+	+	+
07P40	60	80	304	272	+	+	+	+
2P40	60	80	129	97	+	+	+	+
3P40	60	80	164	132	+	+	+	+
4P40	60	80	199	167	+	+	+	+

Table 2

spool control фиксация золотника	E	F
1; 4; 5; 6; 7; 8; 9; 10; 11;	40	193
2; 3;	72	225
16	+	+

0 block with common check valve
 распределитель с общим клапаном
2 number of spools
 количество золотников
P40R directional control valve type ...
 распределитель типа ...
1 inlet high pressure - right
 вход давления с правой стороны
 relief valve; - standard setting 175 bar;
 (svr) relief valve blanking plug; без предох. клапана
 (4) Spring for 160 to 315 bar; standard setting 220 bar;
1 way of distribution/parallel or .../
 способ распределения потока
A first spool distribution type
 характеристика первого золотника
1 spool control/detend and estr./
 контрол золотника/фиксация и дргуе/
A second spool distribution type
 вид второго золотника
1 spool control/detend and estr./
 контрол золотника/фиксация и дргуе/
G ports /treads/
 резьбове отверстия
KZ1 general operation feature
 вид ручного управления
T with "teton"
 исполнение ручного управления с "тетон"
H operation feature /pneumatic, .../
 дргуе управление
E with electric switch
 с электрическим выключателем
C2 high pressure carry over
 продолжител потока високого давления
11 connection ports in use
 присоединительные отверстия

directional control valve P40

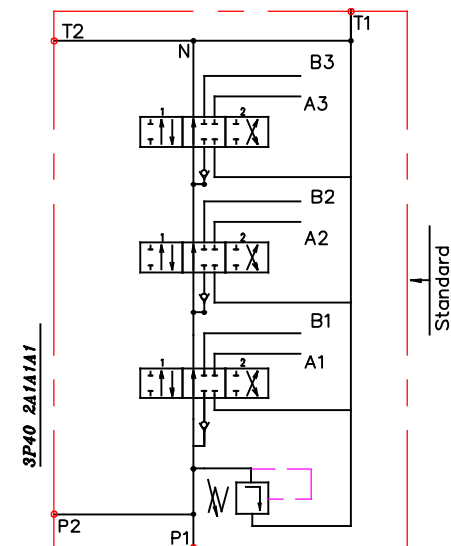
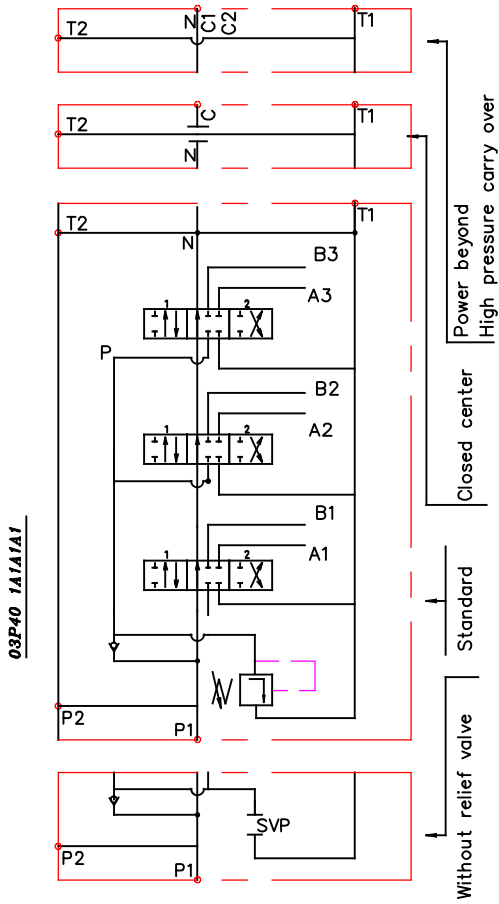

Table 3

code	Number of spools
	1
02, 2	2
03, 3	3

ets.

Table 5

code	spool type
A	
B	
C	
D	
E	
F	
G	
H	
M	
N	
O	
P	
Q	
R	
S	
T	

* K

* только при вход слева (дуг) only for left hand configuration

** L

** только при вход справа (дуг) only for right hand configuration

Table 4

code	way of distribution ; распределение потока
1	parallel ; параллельное
2	tandem(series parallel) ; серийно-параллельное

Table 6

code	spool control
1	
2	
3	
4	
5	
6	
7	
8	
9	
10	
11	

* 15

* 16

* только при вход слева only for left hand configuration

** 12

** 13

** только при вход справа only for right hand configuration

Table 7

code	с микро шалтер ; incorporated microswitch
E	<div style="display: inline-block; vertical-align: middle;"> <p>mikroswitch type Omron-V 165 I C5</p> </div>

Table 8

code	другое управление ; operation feature
P	<p>пневматическое on-off pneumatic control; 5-10 bar ; ports NPTF 1/8-27</p>
H	<p>гидравлическое on-off hydraulic control ; pn = 5 - 20 bar ; ports G1/4</p>

directional control valve P40

Table 9

P40

code ports (threads) ; присоединительные отверстия

	P	A ; B	T	N
M	M22x1.5	M18x1.5	M22x1.5	M22x1.5
G	G1/2	G3/8	G1/2	G1/2
G1/2	G1/2	G1/2 on request	G1/2	G1/2
S	7/8-14UNF	3/4-16UNF	7/8-14UNF	7/8-14UNF

kind of hand control ; вид ручного управления

Table 10

code	ескиз feature	code	ескиз feature	code	ескиз feature
KZ		KY		KI	
KZ1		KY1		KI1	
KZ0		KY0		KI0	
KZ01		KY01		KI01	
-	without hand control ; без лостова система за управление				

Table 11



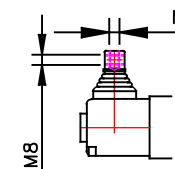
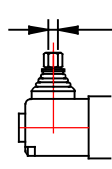
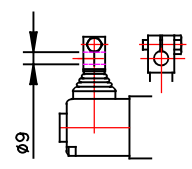
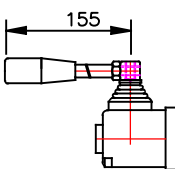
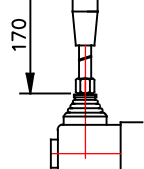
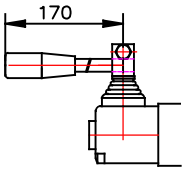
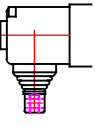
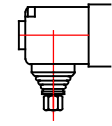
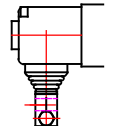
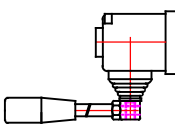
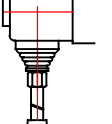
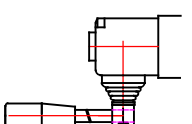

code	вид продължение на дебита	
C	отвор "N" затворен closed center	
C1	отвор "N" продължава за следващ консуматор part for power beyond sleeve (carry over)	 ø14 mm M22x1.5
C2	отвор "N" продължава за следващ консуматор part for power beyond sleeve (carry over)	 G 1/2 M22x1.5
-	отвор "N" е свързан с "T" without part for pressure carry over	
X	отвор "N" е винаги свързан с "T" power beyond ever to tank	

Table 12

code	used connection ports ; присоединительные отверстия
11	P1 ; T1
12	P1 ; T2
21	P2 ; T1
22	P2 ; T2



P40 directional control valve

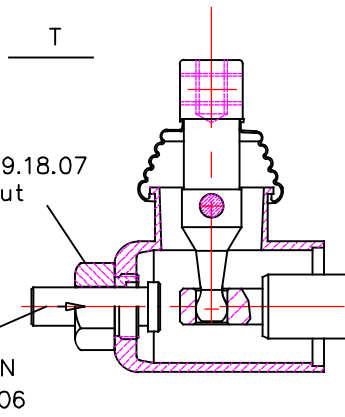
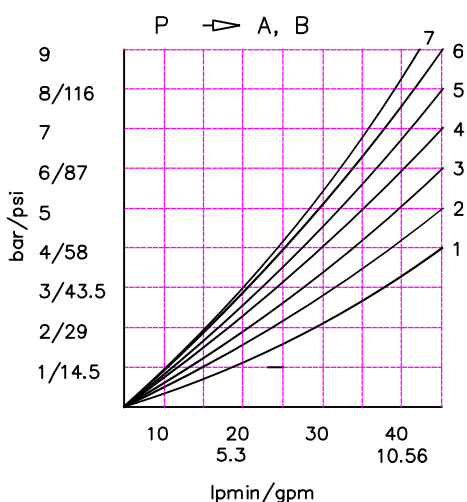
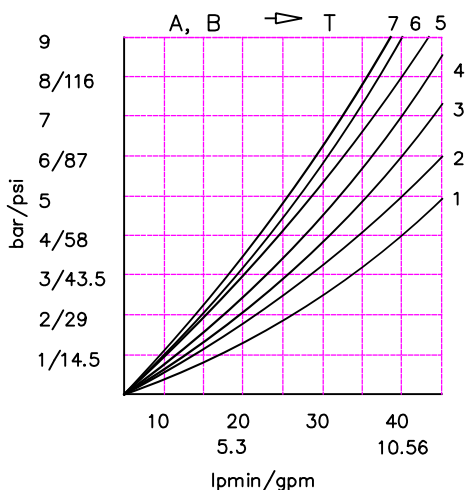
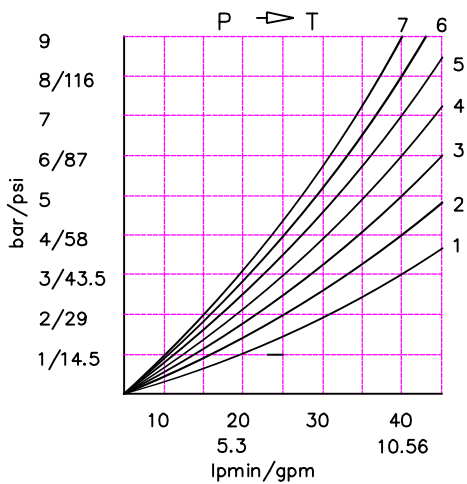

REMOTE CONTROLS
 Управление тросом

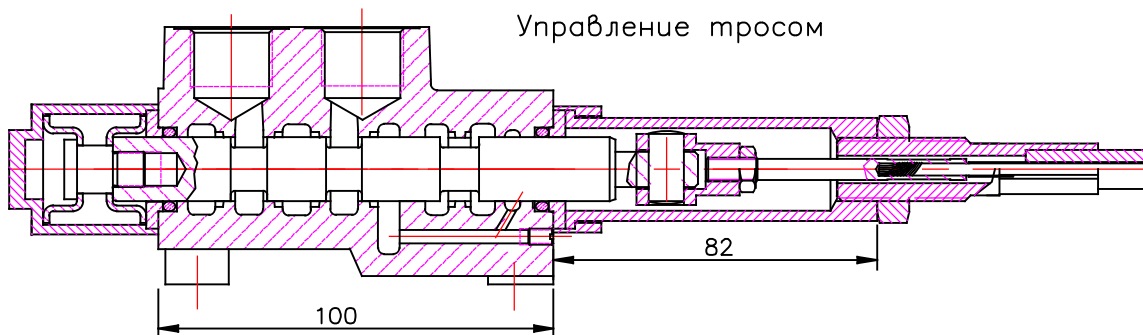

P40 A1G V1(l= . . .)+ 3047
 spool valve cable control body

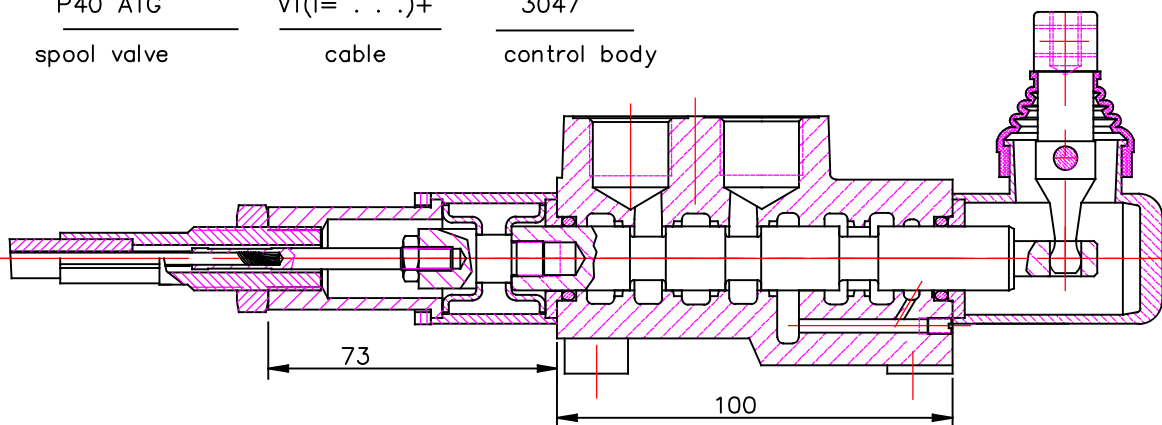

P40 A1GKZ V2(l= . . .)+ 3047
 spool valve cable control body

Cable "INDEMAR" Cod. IT 3056 /l=1.00; 1.50; 2.00; 2.50; 3.00 m/
 +control body "INDEMAR"
 code 3047, 3076, 3077

Technical specifications

	3047	3076	3077
Stroke	13+13 mm	13+13 mm	13+13 mm
Max. load	45 kg	45 kg	45 kg
Level ratio	10:1	10:1	10:1
Lock in neutral	No	No	Yes
Antireverse lock	No	Yes	No
Body colour	Black	Black	Black
Cables type	Heavy Duty	Heavy Duty	Heavy Duty
Operating temperature	-40/+80C	-40/+80C	-40/+80C

High solidity controls for easy mounting on every type of distributor. They can be mounted stand alone or packed together. They use push-pull heavy duty cables that provide a positive smooth operating lever and are manufactured in a three different models to meet different needs of Clients.

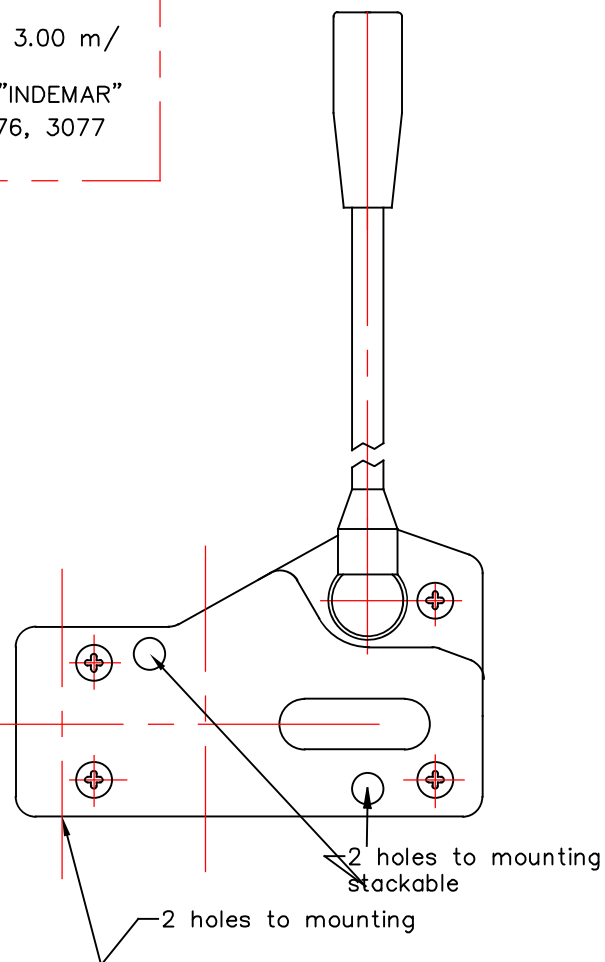

JOYSTICK "+"

This control gives the possibility to operate, at the same time two spools with a "+" movement.

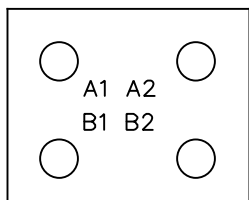
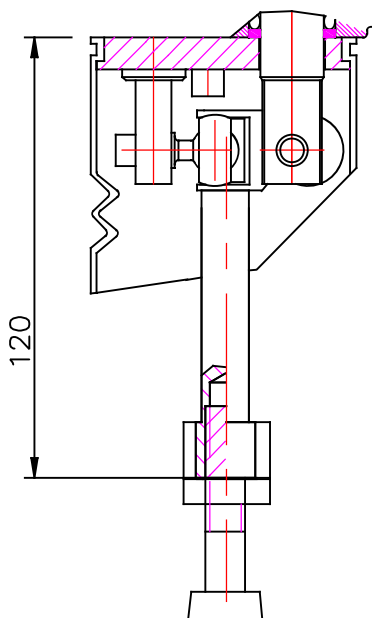

standard version 1

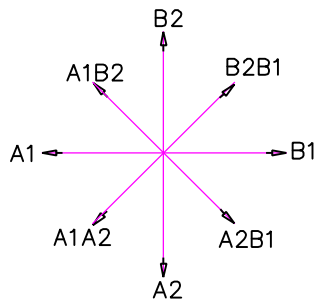
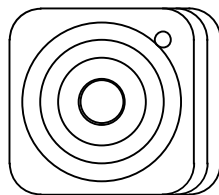

standard version 2

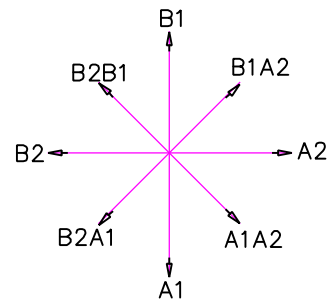
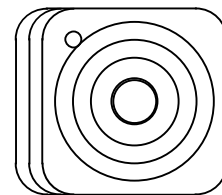

standard version 3

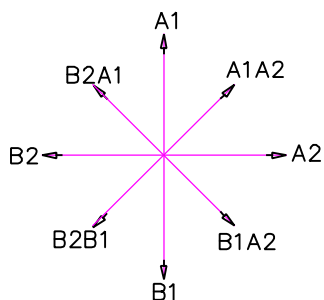
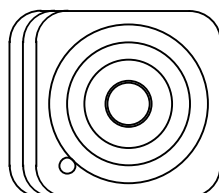

standard version 4

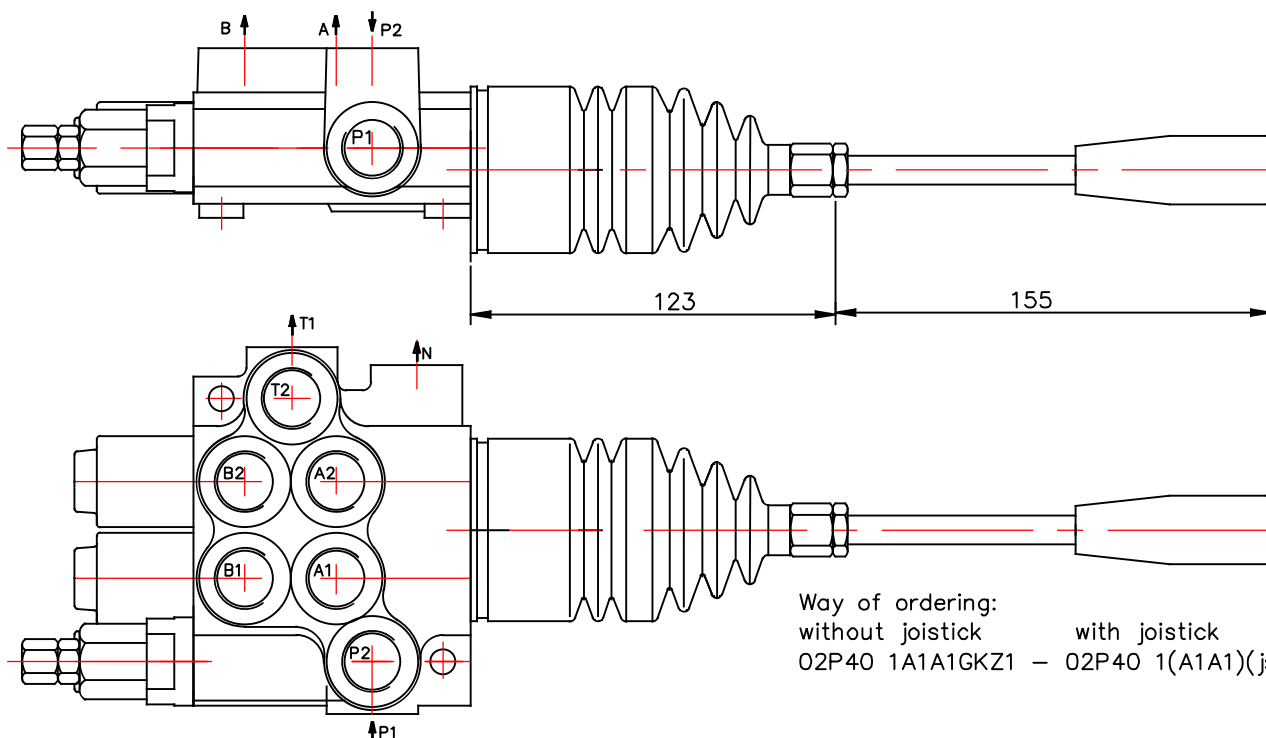
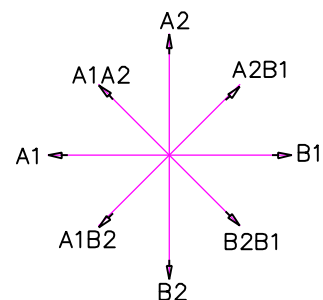
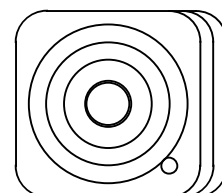

Way of ordering:
 without joystick with joystick
 02P40 1A1A1GKZ1 - 02P40 1(A1A1)(js+3)G